

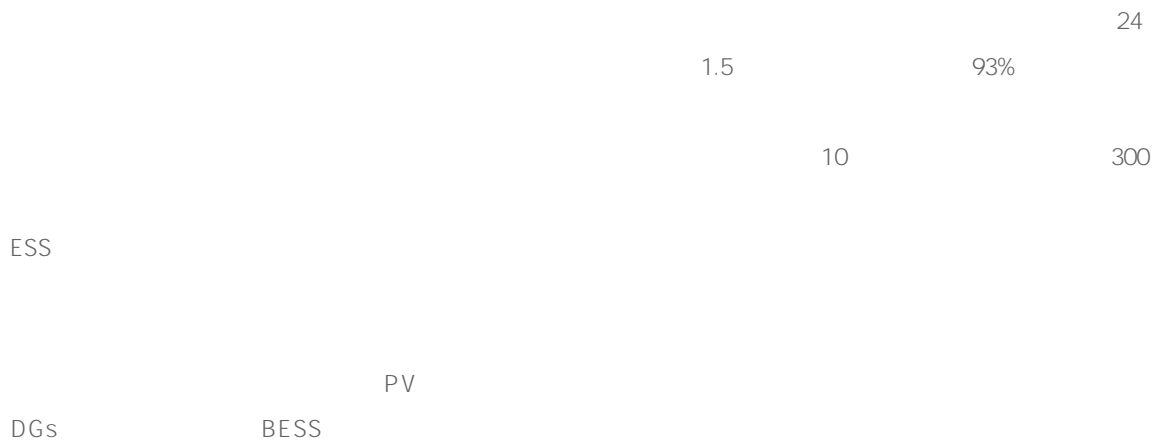

250kW/645kWh

Case Study

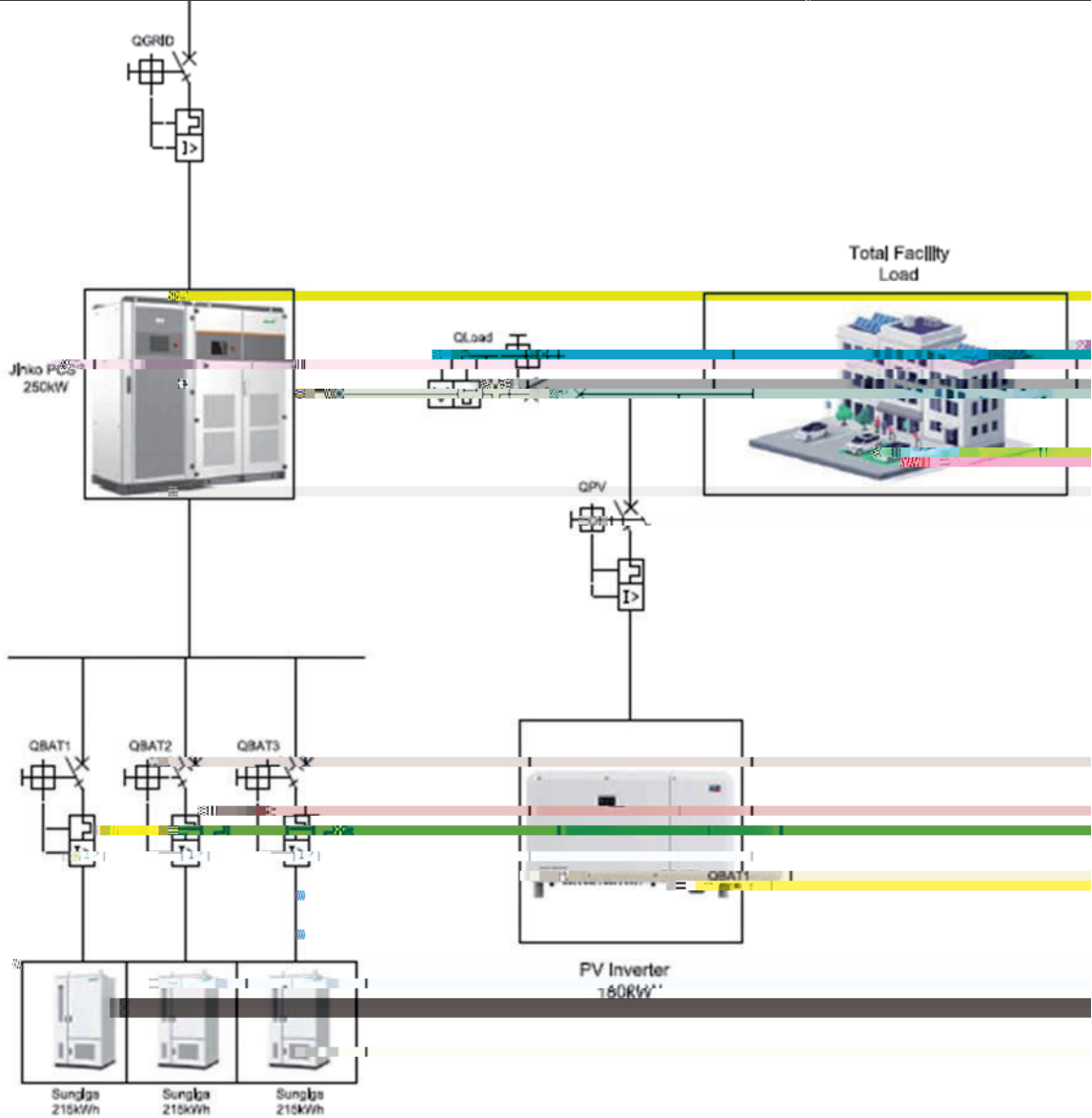

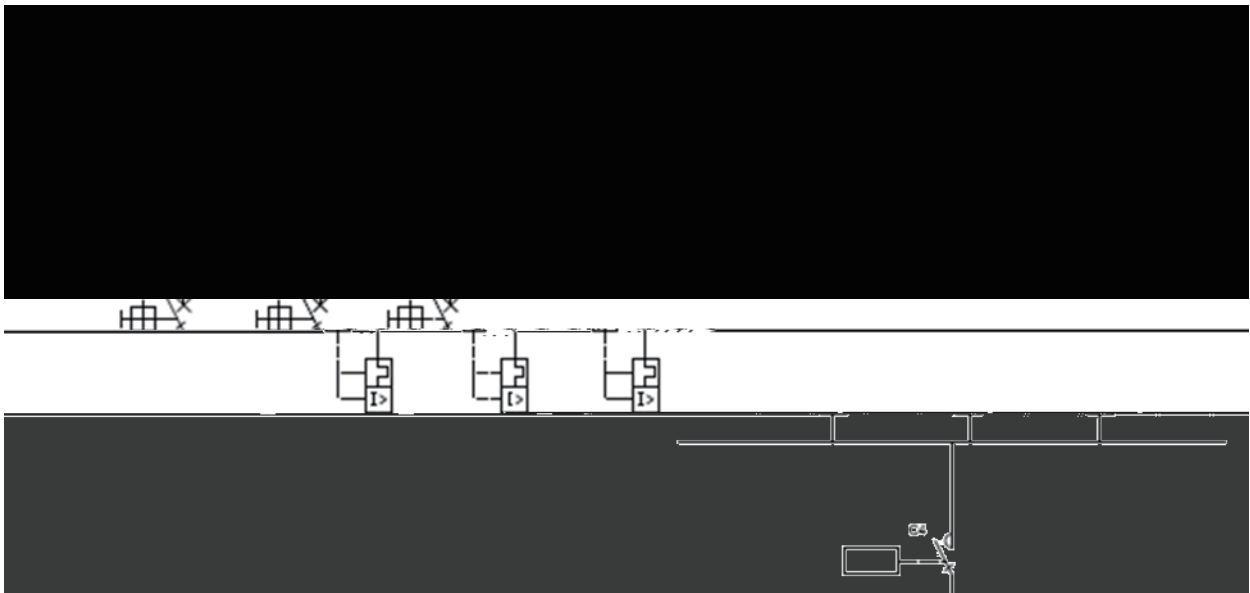

645kWh Jinko SunGiga

645kWh

BMS

EMS

215kWh

5 153.6V

768V

BMU

BCU

BMS

SOC

SOH

4kW

ESS

ESS

Battery Rack

PCS

HVB
BCU

BMS

CAN

BCU

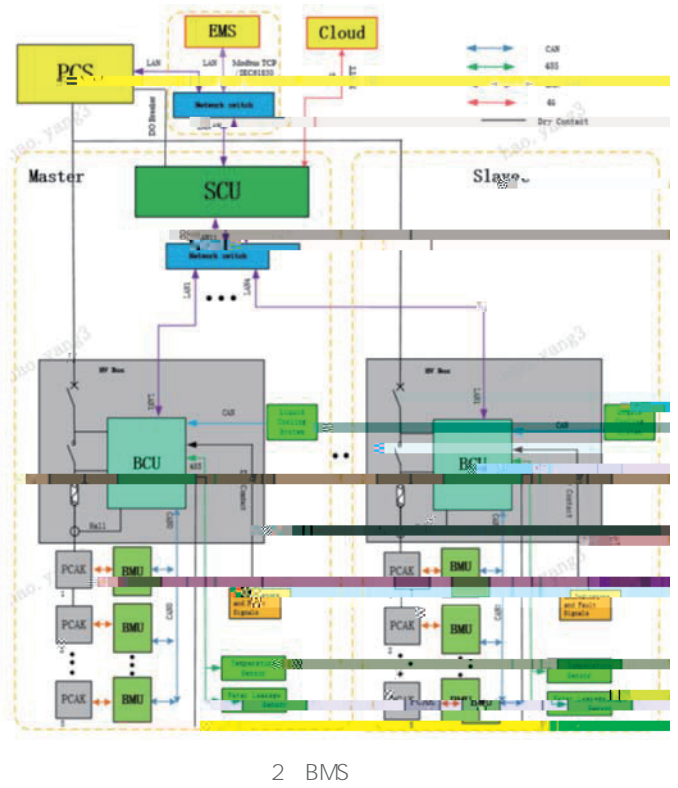

2 BMS

PCS

250kW

PCS

DG

PV Inverters

Grid Following

Grid Forming

PCS

DC-AC

PQ

DC-AC

VF

DC-AC

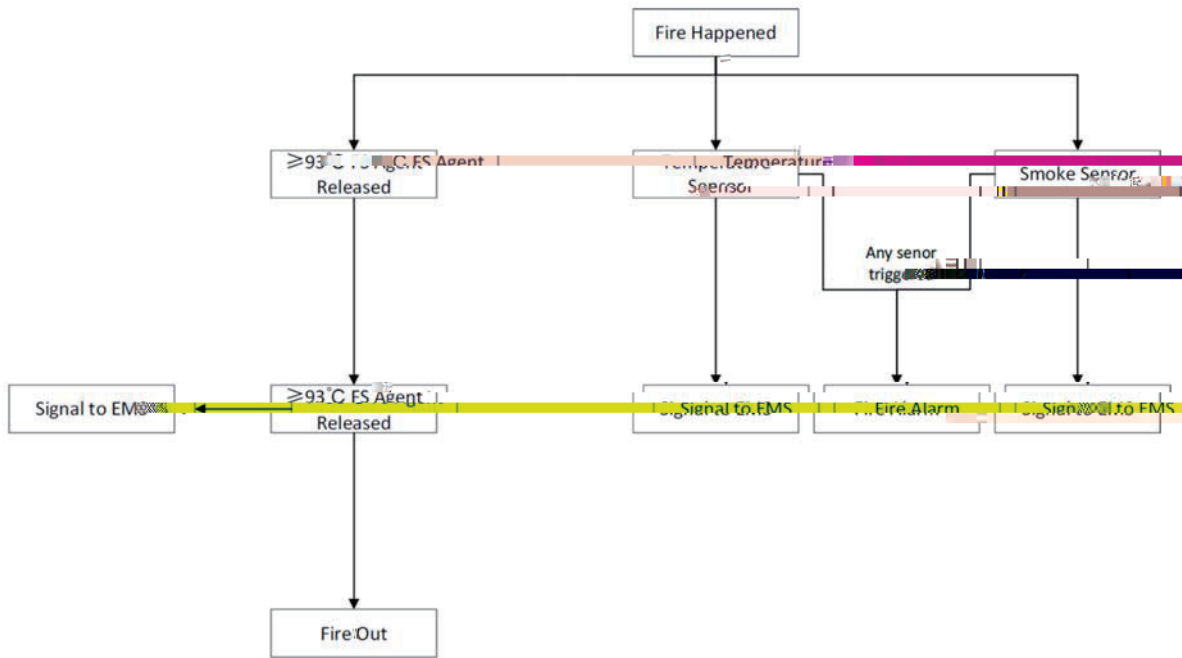

3



4 PCS



SCU

SCU

3

FSS

BMUs

BCUs

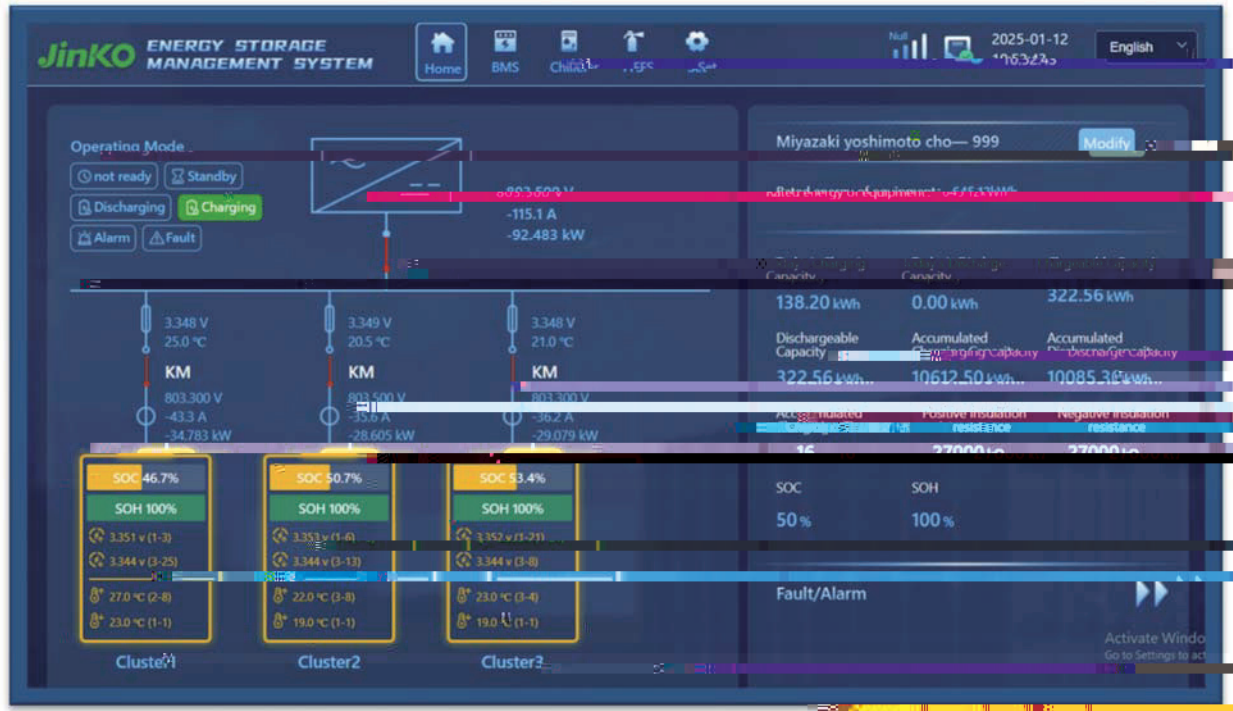

6 SCU



7

IoT

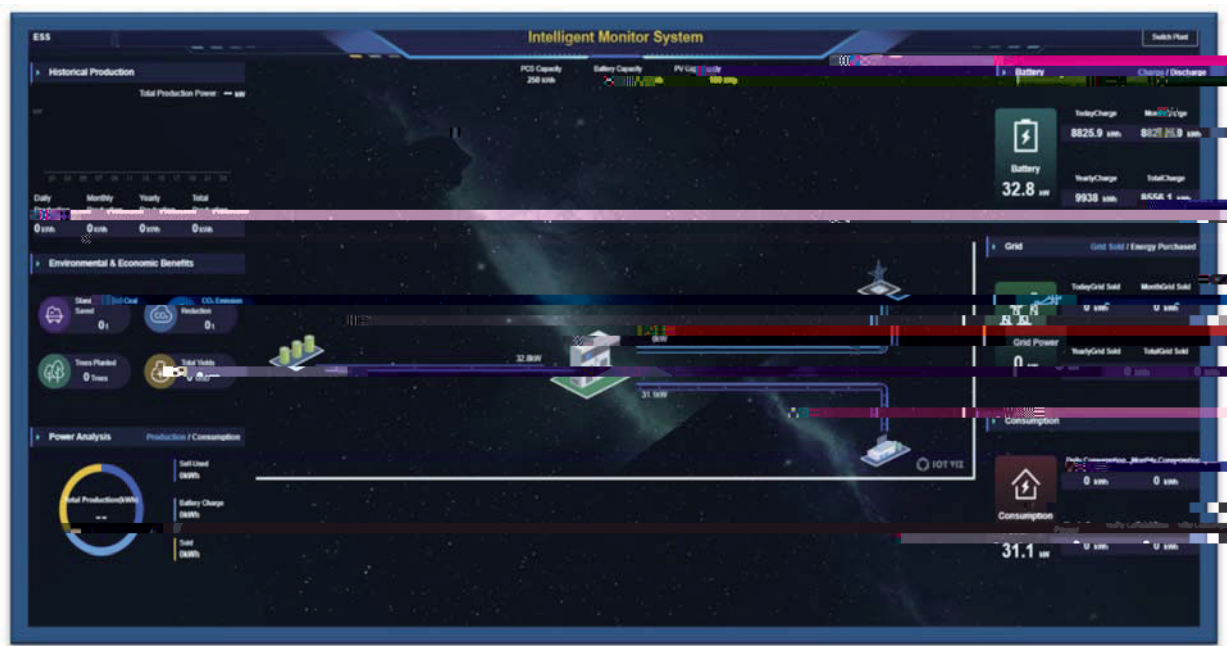

8 EMS

20% SOC 90

SOC

90%

100%

9

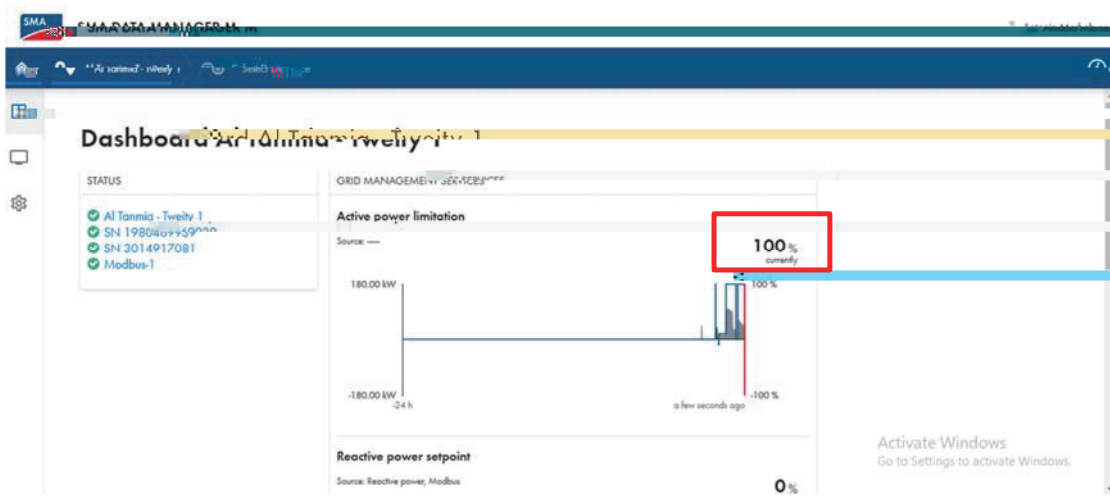

9 SMA

EMS

100%

90% SOC 95

98% SOC

P

